

Data Sheet



Article number: 259618003050

Description: Flange B5
for Bonfiglioli motor size BN 180

Measures

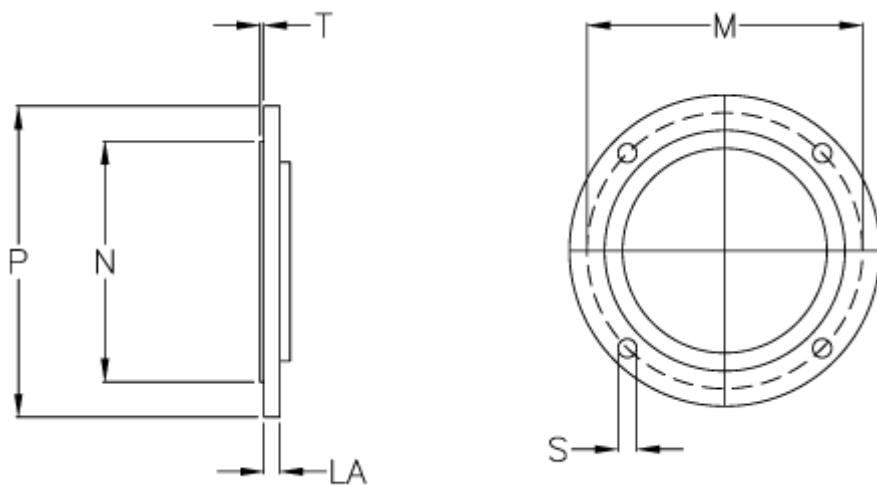

LA = 15.0

M = 300

N = 250

P = 350

S = 18,5

Size = BN 180 B5

T = 5.0